

????

????

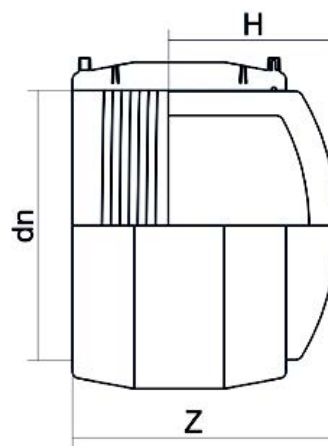

PRODUCT DETAILS		GEOMETRIC CHARACTERISTICS	
ITEM CODE	CAEP032C	d_n	32
d_n	32	H [mm]	60
SDR DESIGN	11	Z [mm]	103
		Mass [kg]	0.09

*The pictures are for illustrative purposes only. the product may differ in color and / or some of its parts.

PLASTITALIA SPA reserves the right to revise this specification, while maintaining compliance with the requirements of the product without prior notice. Tolerance on diameters and thickness according to the standards unless otherwise specified. Tolerance: $\pm 5\%$